



Rigid Liner

5"-8" Diameter Stainless Steel Chimney Liner



TABLE OF CONTENTS

Product Specifications.....	3
Typical Installations.....	4
Kits.....	5
Lengths.....	6
Stainless Steel Elbows and Tees.....	7
Parts & Accessories.....	8-9

RIGID STAINLESS STEEL CHIMNEY LINER

5" to 8" Diameter



Rigid Stainless Steel Liner for Wood, Oil or Gas Appliances

- Use Rigid Lengths inside straight chimneys
- Available in a Kit, or individual component parts
- Optional one-piece Insulation Blanket allows you to wrap the liner system where required or desired
- Selkirk Round Raincap termination attaches without screws
- Stainless Flashing with 20 x 20 base
- Tee with 10" branch



Rigid Stainless Steel Liner Specifications

- Rigid Liner Material - 0.016" Type 304 Stainless Steel
- Available in 5", 6", 7" and 8" diameters
- Clearances - 0" between liner and masonry chimney interior
- Insulation - Wraps available in 10' lengths
- Listed To ULC-S635, ULC-S640 in Canada and UL 1777 in USA
- "Smart Choice" Lifetime Warranty



Get the Selkirk Advantage...

The tradition continues....Selkirk is the original innovator of prefabricated Venting systems - and we continue to move forward. Count on Selkirk, the world's most recognizable name in Chimney & Venting, for the widest range of high-performance products to meet your needs.

Typical Installations

Rigid Liner Standard Installation

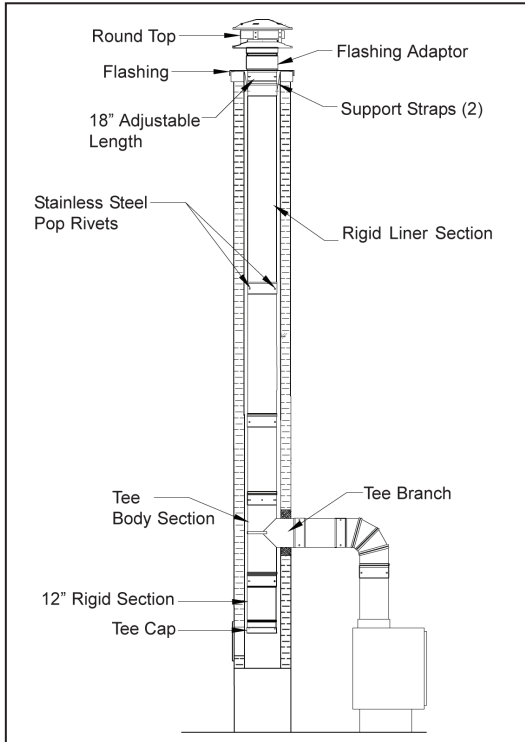

Standard installation of the Rigid Stainless Steel Liner

Rigid Liner Installation with Offset

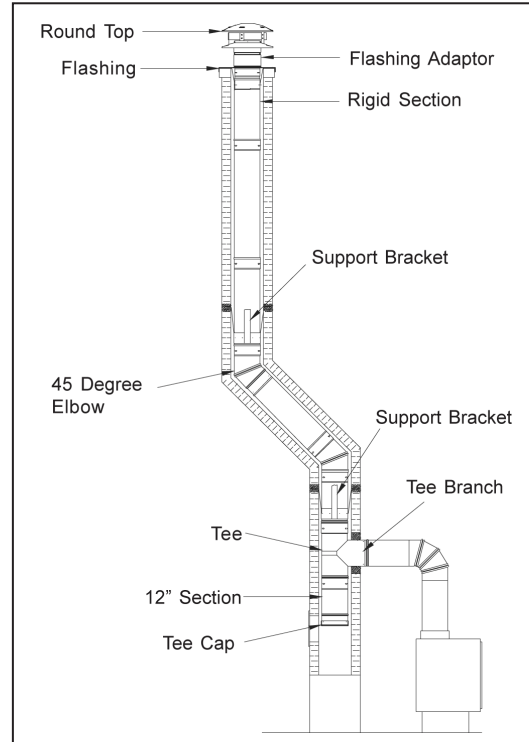

Standard installation of the Rigid Stainless Steel Liner with offset

Rigid Stainless Steel Liner for Wood, Oil or Gas Appliances

Kits

Starter Kit



- The Starter Kit contains most parts required for your installation
- Includes Round Top, Flashing, Flashing Adaptor, Tee w/Cap, 18" Adjustable Length, Support Straps, Tee/Stove Adaptor

SIZE	PRODUCT CODE	PART #	PACK
5"	195165	5RFSK	1
6"	196165	6RFSK	1
7"	197165	7RFSK	1
8"	198165	8RFSK	1

Insulation Wrap Kit



- 10 ft. Kit includes foil-backed insulation, wire mesh, stainless steel ties and aluminum tape
- Reduces heat loss to maintain high flue temperatures
- A requirement for UL 1777 - allows for reduced clearance to combustibles (see installation instructions for details)

SIZE	PRODUCT CODE	PART #	PACK
5"	195120	5RF10I	1
6"	196120	6RF10I	1
7"	197120	7RF10I	1
8"	198120	8RF10I	1

Rigid Stainless Steel Liner for Wood, Oil or Gas Appliances

Lengths

Pipe Length

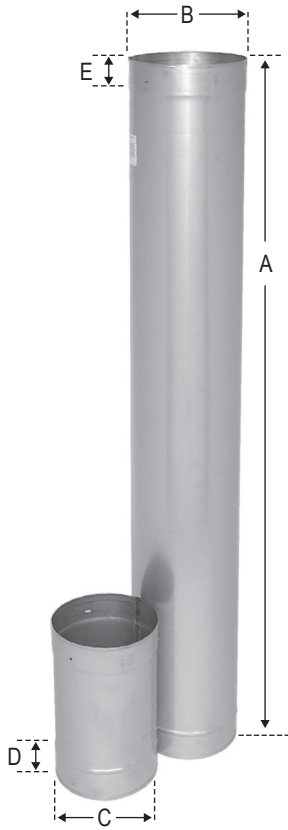

- Lengths are 304 Stainless Steel
- Available in Lengths of 6", 12", 24", 36" and 48"
- Available in diameters of 5", 6", 7" and 8"
- Three rivets per Length

SIZE	DIMENSIONS					PRODUCT CODE	PART #	PACK
	A	B	C	D	E			
5"	47.5"	5"	4-7/8"	2"	2-1/8"	195048	5RF48	4
6"	47.5"	6"	5-7/8"	2"	2-1/8"	196048	6RF48	4
7"	47.5"	7"	6-7/8"	2"	2-1/8"	197048	7RF48	4
8"	47.5"	8"	7-7/8"	2"	2-1/8"	198048	8RF48	4
5"	35.5"	5"	4-7/8"	2"	2-1/8"	195036	5RF36	4
6"	35.5"	6"	5-7/8"	2"	2-1/8"	196036	6RF36	4
7"	35.5"	7"	6-7/8"	2"	2-1/8"	197036	7RF36	4
8"	35.5"	8"	7-7/8"	2"	2-1/8"	198036	8RF36	4
5"	23.5"	5"	4-7/8"	2"	2-1/8"	195024	5RF24	1
6"	23.5"	6"	5-7/8"	2"	2-1/8"	196024	6RF24	1
7"	23.5"	7"	6-7/8"	2"	2-1/8"	197024	7RF24	1
8"	23.5"	8"	7-7/8"	2"	2-1/8"	198024	8RF24	1
5"	12"	5"	4-7/8"	2"	2-1/8"	195012	5RF12	1
6"	12"	6"	5-7/8"	2"	2-1/8"	196012	6RF12	1
7"	12"	7"	6-7/8"	2"	2-1/8"	197012	7RF12	1
8"	12"	8"	7-7/8"	2"	2-1/8"	198012	8RF12	1
5"	6"	5"	4-7/8"	2"	2-1/8"	195006	5RF6	1
6"	6"	6"	5-7/8"	2"	2-1/8"	196006	6RF6	1
7"	6"	7"	6-7/8"	2"	2-1/8"	197006	7RF6	1
8"	6"	8"	7-7/8"	2"	2-1/8"	198006	8RF6	1

Adjustable Length

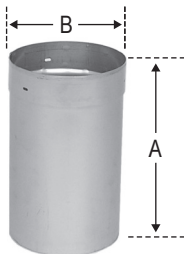

- Used to adjust the liner to the required length
- Adjustable from 4-1/2" to 14"

SIZE	DIMENSIONS		PRODUCT CODE	PART #	PACK
	A	B			
5"	18"	5"	195084	5RFAL	1
6"	18"	6"	196084	6RFAL	1
7"	18"	7"	197084	7RFAL	1
8"	18"	8"	198084	8RFAL	1

Rigid Stainless Steel Liner for Wood, Oil or Gas Appliances

Elbows & Tee

45 Degree Elbow

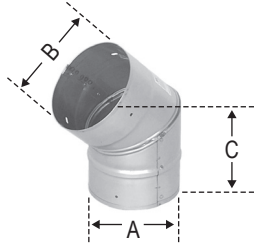

- Use in an offset installation

SIZE	DIMENSIONS			PRODUCT CODE	PART #	PACK
	A	B	C			
5"	4-7/8"	5"	7-15/16"	195215	5RF45	1
6"	5-7/8"	6"	8-3/8"	196215	6RF45	1
7"	6-7/8"	7"	8-5/8"	197215	7RF45	1
8"	7-7/8"	8"	9-1/16"	198215	8RF45	1

90 Degree Elbow

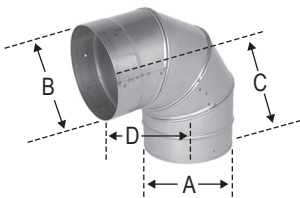

- Use in an offset installation

SIZE	DIMENSIONS				PRODUCT CODE	PART #	PACK
	A	B	C	D			
5"	4-7/8"	5"	6-3/4"	6-3/8"	195230	5RF90	1
6"	5-7/8"	6"	7-3/8"	6-3/4"	196230	6RF90	1
7"	6-7/8"	7"	7-3/4"	7-3/8"	197230	7RF90	1
8"	7-7/8"	8"	8-3/8"	7-3/4"	198230	8RF90	1

Tee Section with Cap

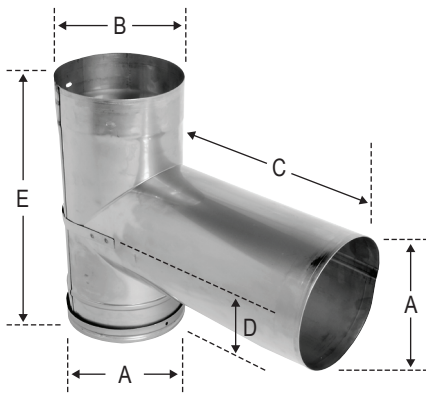

- 2 piece design for easy installation into a masonry chimney
- Comes complete with Tee Cap
- Tee branch may be cut to size where required

SIZE	DIMENSIONS					PRODUCT CODE	PART #	PACK
	A	B	C	D	E			
5"	4-7/8"	5"	10"	6-1/2"	13"	195100	5RFTE	1
6"	5-7/8"	6"	10"	6-1/2"	13"	196100	6RFTE	1
7"	6-7/8"	7"	10"	6-1/2"	13"	197100	7RFTE	1
8"	7-7/8"	8"	10"	6-1/2"	13"	198100	8RFTE	1

Rigid Stainless Steel Liner for Wood, Oil or Gas Appliances

Parts & Accessories

Flashing & Flashing Adapter

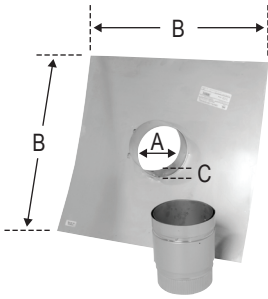

- Used at the top of the masonry chimney as support

SIZE	DIMENSIONS			PRODUCT CODE	PART #	PACK
	A	B	C			
5"	5-3/8"	20"	3"	195850	5RFFA	1
6"	6-3/8"	20"	3"	196850	6RFFA	1
7"	7-3/8"	20"	3"	197850	7RFFA	1
8"	8-3/8"	20"	3"	198850	8RFFA	1

Round Top

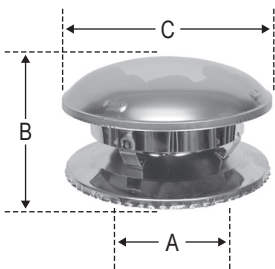

- Advanced design, premium quality stainless steel
- Provides protection against precipitation and creates a venturi effect to enhance draught
- Secured in position with stainless steel screws providing easy removal for inspection and cleaning

SIZE	DIMENSIONS			PRODUCT CODE	PART #	PACK
	A	B	C			
5"	4-7/8"	7-3/4"	10"	195800	5RFRT	1
6"	5-7/8"	8-1/2"	12"	196800	6RFRT	1
7"	6-7/8"	9-1/8"	14"	197800	7RFRT	1
8"	7-7/8"	10"	16"	198800	8RFRT	1

DIKAPT (Anti Downdraft Cap)

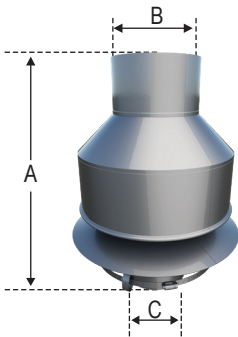

- Provides protection from wind and rain during cold chimney conditions
- Ensures normal flow of hot gases during windy conditions
- Constructed of 300 Series Stainless Steel

SIZE	DIMENSIONS			PRODUCT CODE	PART #	PACK
	A	B	C			
5"	17-1/4"	6"	4-3/4"	195802	5RFDK	1
6"	19-1/4"	7"	5-3/4"	196802	6RFDK	1
7"	19-1/4"	8"	6-3/4"	197802	7RFDK	1
8"	19-1/4"	9"	7-3/4"	198802	8RFDK	1
10"	19-1/4"	11"	9-3/4"	1910802	10RFDK	1

Flex Connector

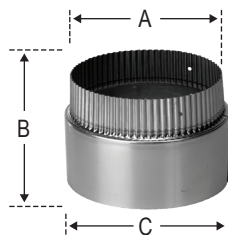

- Fitting used for joining Flex and Rigid components
- Crimped for ease of assembly

SIZE	DIMENSIONS			PRODUCT CODE	PART #	PACK
	A	B	C			
4"	4"	3.97"	5.35"	174060	SF4-FC	1
5"	5"	4.97"	6.35"	175060	5RFFC	1
6"	6"	5.97"	7.35"	176060	6RFFC	1
7"	7"	6.97"	8.35"	177060	7RFFC	1
8"	8"	7.97"	9.35"	178060	8RFFC	1

Rigid Stainless Steel Liner for Wood, Oil or Gas Appliances

Parts & Accessories

5" Flex to 6" Stove Adapter



- Provides transition from a 6" appliance outlet to a 5" diameter Flex Liner
- Crimped for ease of assembly

SIZE	DIMENSIONS			PRODUCT CODE	PART #	PACK
	A	B	C			
5" to 6"	6"	6-1/4"	5"	175230	5RF6SA	1

Increaser

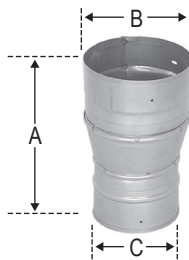

- To increase liner to a larger diameter

SIZE	DIMENSIONS			PRODUCT CODE	PART #	PACK
	A	B	C			
5" to 6"	9-3/8"	6"	4-7/8"	195306	5RF6I	1
6" to 7"	9-3/8"	7"	5-7/8"	196307	6RF7I	1
7" to 8"	9-3/8"	8"	6-7/8"	197308	7RF8I	1

Reducer



- To reduce liner to a smaller diameter

SIZE	DIMENSIONS			PRODUCT CODE	PART #	PACK
	A	B	C			
6" to 5"	9-3/8"	5"	5-7/8"	196365	6RF5R	1
7" to 6"	9-3/8"	6"	6-7/8"	197366	7RF6R	1
8" to 7"	9-3/8"	7"	7-7/8"	198367	8RF7R	1

Trim Plate

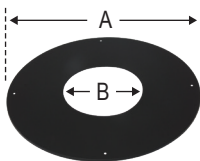

- Matte black finish provides a decorative finish to installation.
- Has four holes with black screws for mounting.

SIZE	DIMENSIONS			PRODUCT CODE	PART #	PACK
	A	B				
5"	12"	5-1/8"		195500	5RFTP	1
6"	12"	6-1/8"		196500	6RFTP	1
7"	14"	7-1/8"		197500	7RFTP	1
8"	14"	8-1/8"		198500	8RFTP	1

Support Bracket

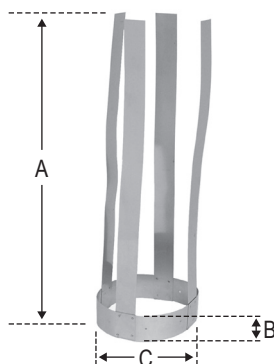

- Additional support for liner, also used above each offset
- Used only with rigid components

SIZE	DIMENSIONS			PRODUCT CODE	PART #	PACK
	A	B	C			
5"	22"	2"	5"	195200	SL5SB	1
6"	22"	2"	6"	196200	SL6SB	1
7"	22"	2"	7"	197200	SL7SB	1
8"	22"	2"	8"	198200	SL8SB	1



BUILD FOR THE FUTURE

Customer Service and Support:

Airmate (USA).....	800.992.8368
Airmate (CAN)	888.735.5475
Ameriflow	800.252.8467
Amerivent (Retail).....	800.252.8467
Amerivent (Hearth & Wholesale)	800.423.4270
Amerivent (Support).....	800.748.0392
AMPCO (USA)	800.669.3269
AMPCO (CAN).....	888.735.5475
Duravent	800.835.4429
Hart & Cooley.....	800.433.6341
Hart & Cooley (Support)	800.748.0392
Heatfab (USA).....	800.772.0739
Heatfab (CAN)	800.848.2149
Lima.....	800.423.4270
Milcor	800.774.5240
Portals Plus.....	800.774.5240
RPS.....	800.624.8642
Security Chimney (USA).....	800.361.4909
Security Chimney (CAN)	800.667.3387
Selkirk (USA) Residential	800.992.8368
Selkirk (USA) Commercial.....	800.848.2149
Selkirk (USA) Support.....	800.748.0392
Selkirk (CAN)	888.735.5475

Manufacturing & Distribution Centers:

CANADA	
Nobel, ON	Manufacturing
Laval, QC	Manufacturing
Prescott, ON	Distribution
USA	
Grand Rapids, MI	Center of Excellence
Dallas, TX	Distribution
Englewood, OH	Distribution
Huntsville, AL	Manufacturing & Distribution
Las Vegas, NV	Distribution
Nampa, ID	Manufacturing & Distribution
Turner Falls, MA	Manufacturing & Distribution
Vacaville, CA	Manufacturing
MEXICO	
Ojinaga, MX	Manufacturing
Mexicali, MX	Manufacturing

Corporate Headquarters:

Duravent Group
 28 W. Adams, Suite 1810
 Detroit, MI 48226
 Tel: 800.835.4429
 Email: info@duraventgroup.com
www.duraventgroup.com



duravent[™]
GROUP

BUILD FOR THE FUTURE

www.duraventgroup.com



For warranty information:
Scan this QR code or visit
www.duraventgroup.com/warranties